

Arandelas PLANAS

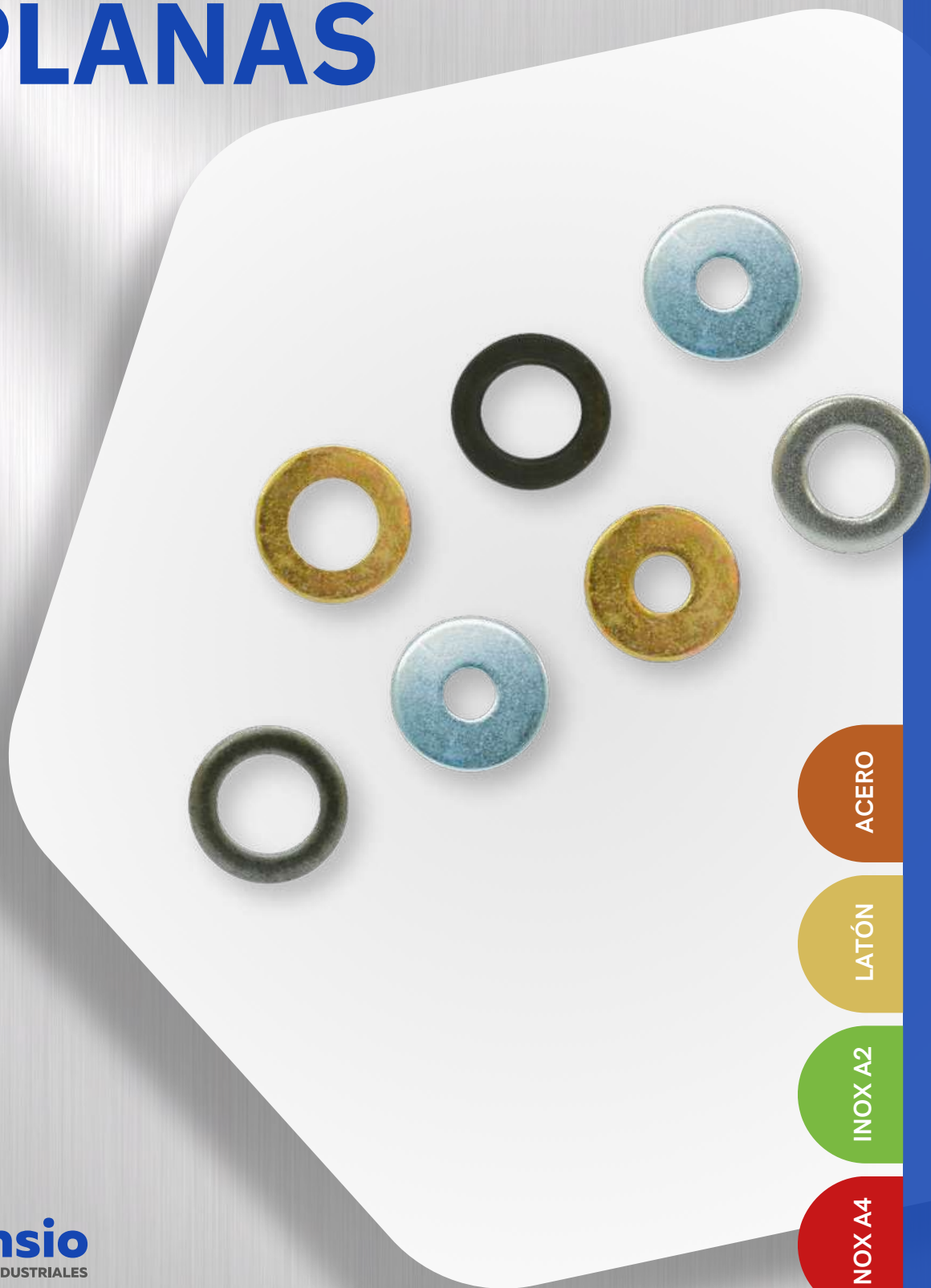

ACERO

LATÓN

INOX A2

INOX A4



Asensio
SUMINISTROS INDUSTRIALES



ARANDELAS PLANAS



DIN 125 / ISO 7089 (EQUIVALENTE)

ARANDELA PLANA

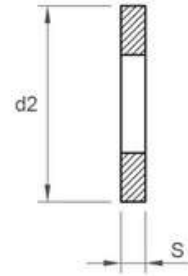
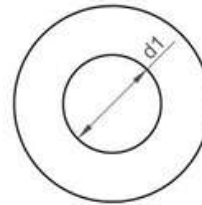

METRICA	3	4	5	6	7	8	10	12	14	16	18	20	22	24	27	30	33	36	39	42
---------	---	---	---	---	---	---	----	----	----	----	----	----	----	----	----	----	----	----	----	----

METRICA	45	48	52	56	60	64	68	72	76	80	90	99
---------	----	----	----	----	----	----	----	----	----	----	----	----



FICHA TÉCNICA DISPONIBLE:

comercial@suministrosasensio.com

Tel.: 976 731 568

ACERO



ARANDELAS PLANAS

DIN 125 ZN / ISO 7089 (EQUIVALENTE)

ARANDELA PLANA ZINCADA

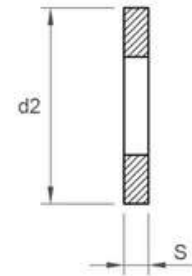
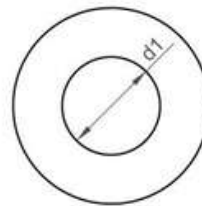

METRICA 4 5 6 7 8 10 12 14 16 18 20 22 24

METRICA 27 30 33 36 39 42 45 48 52 56 60



FICHA TÉCNICA DISPONIBLE:

comercial@suministrosasensio.com

Tel.: 976 731 568



ARANDELAS PLANAS



DIN 125 BR / ISO 7089 (EQUIVALENTE)

ARANDELA PLANA BICROMATADA

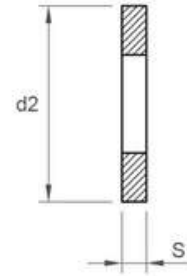
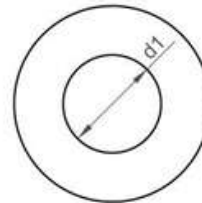

METRICA	3	4	5	6	7	8	10	12	14	16	18	20	22	24	27	30	33	36
---------	---	---	---	---	---	---	----	----	----	----	----	----	----	----	----	----	----	----



FICHA TÉCNICA DISPONIBLE:

comercial@suministrosasensio.com

Tel.: 976 731 568

ACERO



ARANDELAS PLANAS

DIN 125 HDG / ISO 7089 (EQUIVALENTE)

ARANDELA PLANA GALVANIZADA EN CALIENTE

HDG

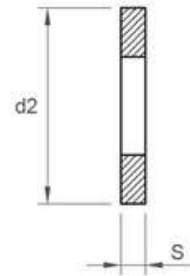
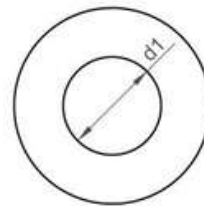

METRICA

6

8

10

12

14

16

18

20

22

24

27

30

33

36



FICHA TÉCNICA DISPONIBLE:

comercial@suministrosasensio.com

Tel.: 976 731 568



ARANDELAS PLANAS



DIN 433 / ISO 7092 (EQUIVALENTE)

ARANDELA PARA TORNILLO CILINDRICO

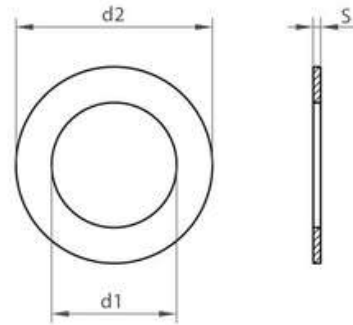

METRICA	4	5	8	10	12	16	18	20
---------	---	---	---	----	----	----	----	----



FICHA TÉCNICA DISPONIBLE:

comercial@suministrosasensio.com

Tel.: 976 731 568

ACERO



ARANDELAS PLANAS

DIN 440 / ISO 7094 (EQUIVALENTE)

ARANDELA PLANA ALA ANCHA. FORMA R. SIN BAÑO

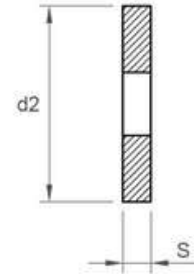
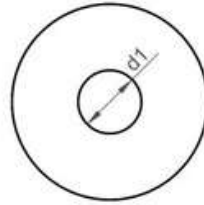

METRICA	5	6	8	10	12	16	20
---------	---	---	---	----	----	----	----



FICHA TÉCNICA DISPONIBLE:

comercial@suministrosasensio.com

Tel.: 976 731 568



ARANDELAS PLANAS

DIN 440 ZN / ISO 7094 (EQUIVALENTE)

ARANDELA ALA ANCHA, FORMA R. ZINCADA

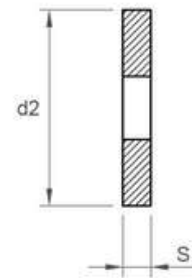
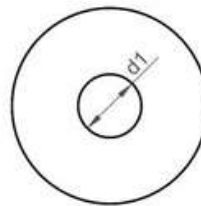

METRICA	5	6	8	10	12	16	20
---------	---	---	---	----	----	----	----



FICHA TÉCNICA DISPONIBLE:

comercial@suministrosasensio.com

Tel.: 976 731 568



ARANDELAS PLANAS



DIN 7349

ARANDELA PLANA SIN BAÑO

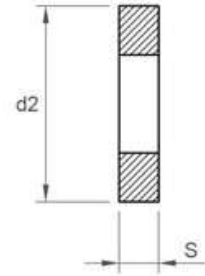
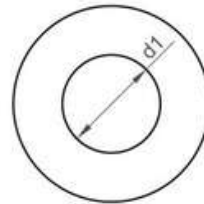

METRICA 4 5 8 10 12 14 16 18 20 22 24 27 30



FICHA TÉCNICA DISPONIBLE:

comercial@suministrosasensio.com

Tel.: 976 731 568

ACERO

Tornillería → ARANDELAS



ARANDELAS PLANAS



DIN 7349 ZN

ARANDELA PLANA ZINCADA

ZN

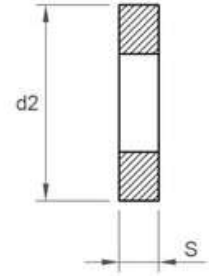
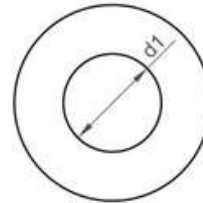

METRICA

5

6

8

10

12

16

18

20

22

24

27

30



FICHA TÉCNICA DISPONIBLE:

comercial@suministrosasensio.com

Tel.: 976 731 568

ACERO

Tornillería → ARANDELAS



ARANDELAS PLANAS



DIN 7989

ARANDELA PLANA SIN BAÑO

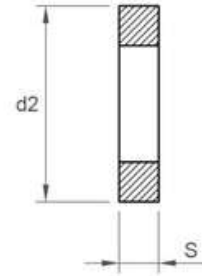
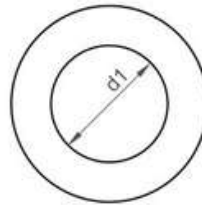

METRICA	12	14	16	20	24	27	30
---------	----	----	----	----	----	----	----



FICHA TÉCNICA DISPONIBLE:

comercial@suministrosasensio.com

Tel.: 976 731 568

ACERO

Tornillería → ARANDELAS



ARANDELAS PLANAS



DIN 7989 HDG

ARANDELA PLANA GALVANIZADA EN CALIENTE

HDG

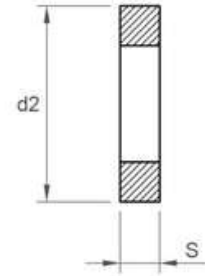
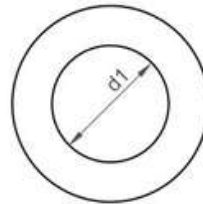

METRICA	12	16	22	24
---------	----	----	----	----



FICHA TÉCNICA DISPONIBLE:

comercial@suministrosasensio.com

Tel.: 976 731 568

ACERO

Tornillería → ARANDELAS



ARANDELAS PLANAS



DIN 9021 / ISO 7093 (EQUIVALENTE)

ARANDELA PLANA SIN BAÑO

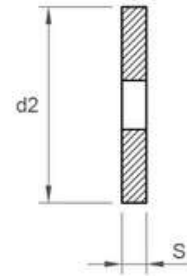
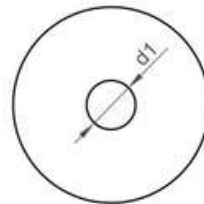

METRICA	3	4	5	6	7	8	10	12	14	16	18	20	22	24	30
---------	---	---	---	---	---	---	----	----	----	----	----	----	----	----	----



FICHA TÉCNICA DISPONIBLE:

comercial@suministrosasensio.com

Tel.: 976 731 568

ACERO



ARANDELAS PLANAS



DIN 9021 ZN / ISO 7093 (EQUIVALENTE)

ARANDELA PLANA ZINCADA

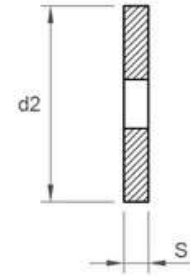
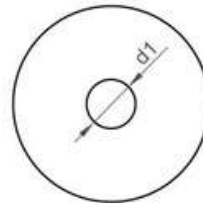

METRICA

3

4

5

6

7

8

10

12

14

16

18

20

22

24

30



FICHA TÉCNICA DISPONIBLE:

comercial@suministrosasensio.com

Tel.: 976 731 568

ACERO

Tornillería → ARANDELAS



ARANDELAS PLANAS



DIN 9021 BR / ISO 7093 (EQUIVALENTE)

ARANDELA PLANA BICROMATADA

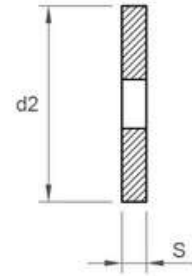
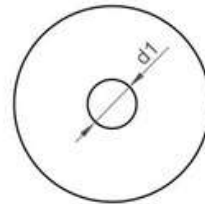

METRICA	5	7	8	10	12	14	16	18	20
---------	---	---	---	----	----	----	----	----	----



FICHA TÉCNICA DISPONIBLE:

comercial@suministrosasensio.com

Tel.: 976 731 568

ACERO



ARANDELAS PLANAS

DIN 9021 HDG / ISO 7093 (EQUIVALENTE)

ARANDELA PLANA GALVANIZADA EN CALIENTE

HDG

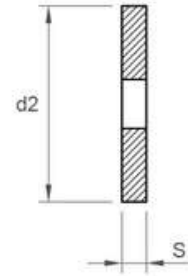
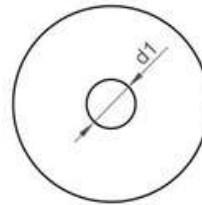

METRICA

8

10

16

20

24



FICHA TÉCNICA DISPONIBLE:

comercial@suministrosasensio.com

Tel.: 976 731 568



ARANDELAS PLANAS



DIN 125 / ISO 7089 (EQUIVALENTE)

ARANDELA PLANA ALTA RESISTENCIA

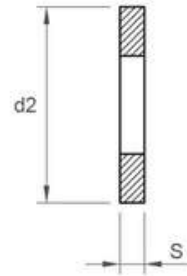
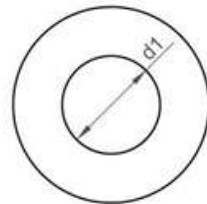

METRICA	6	8	10	12	14	16	18	20	22	24	27	30
---------	---	---	----	----	----	----	----	----	----	----	----	----



FICHA TÉCNICA DISPONIBLE:

comercial@suministrosasensio.com

Tel.: 976 731 568

ACERO



ARANDELAS PLANAS



DIN 125 / ISO 7089 (EQUIVALENTE)

LATON ARANDELA PLANA

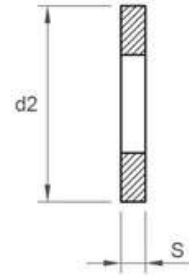
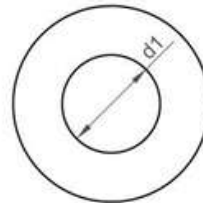

METRICA 3 4 5 6 7 8 10 11 12 14 16 18 20 22 24 26 27 30 42 48



FICHA TÉCNICA DISPONIBLE:

comercial@suministrosasensio.com

Tel.: 976 731 568

LATÓN

Tornillería → ARANDELAS



ARANDELAS PLANAS

DIN 125 / ISO 7089 (EQUIVALENTE)

ARANDELA PLANA INOX.A2

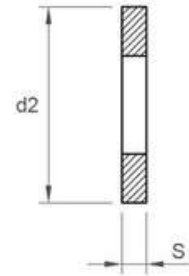
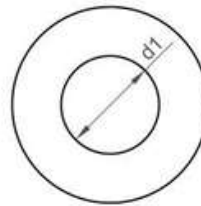

METRICA	3	4	5	6	8	10	12	14	16	18	20	22	24	27	30	33	36	45	39	42	48
S	0,5	0,8	1	1,6	1,6	2	2,5	2,5	3	3	3	3	4	4	4	5	5	8	6	8	8
D2	7	9	10	12	16	20	24	28	30	34	37	39	44	50	56	60	66	85	72	78	92



FICHA TÉCNICA DISPONIBLE:

comercial@suministrosasensio.com

Tel.: 976 731 568



ARANDELAS PLANAS

DIN 9021 / ISO 7093 (EQUIVALENTE)

ARANDELA PLANA INOX.A2

A2

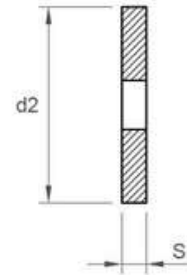
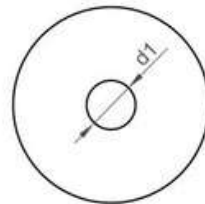

METRICA	3	4	5	6	8	10	12	14	16	18	20	22	24
S	0,8	1	1,2	1,6	2	2,5	3	3	3	4	4	5	5
D2	9	12	15	18	24	30	37	44	50	56	60	66	72
D1												24	



FICHA TÉCNICA DISPONIBLE:

comercial@suministrosasensio.com

Tel.: 976 731 568

INOX



ARANDELAS PLANAS

DIN 9021 / ISO 7093 (EQUIVALENTE)

ARANDELA PLANA INOX.A4

A4

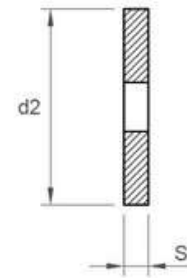
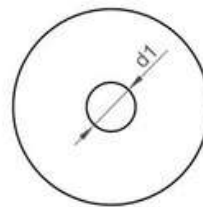

METRICA	3	4	5	6	8	10	12	14	16	18	20	22	24
S	0,8	1	1,2	1,6	2	2,5	3	3	3	4	4	5	5
D2	9	12	15	18	24	30	37	44	50	56	60	66	72



FICHA TÉCNICA DISPONIBLE:

comercial@suministrosasensio.com

Tel.: 976 731 568

INOX